

SMAG Plastic-Encapsulate Diodes

SMAG SERIES Transient Voltage Suppressor Diodes

Features

- P_{PP} 400W
- V_{RWM} 5.0V- 440V
- Glass passivated chip

Applications

- Clamping Voltage

Marking

- SMAJXX(A/C/CA)
- XX : From 5.0 To 440

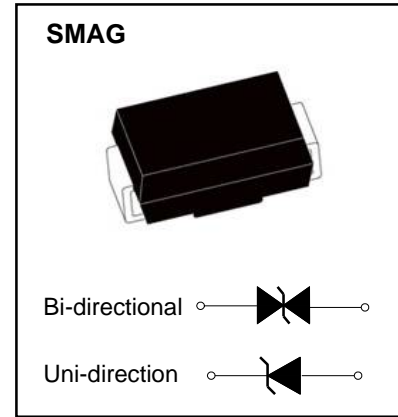

Limiting Values (Absolute Maximum Rating)

Item	Symbol	Unit	Conditions	Max
Peak pulse power dissipation	P _{PPM}	W	with a 10/1000us waveform	400
Peak pulse current (1)	I _{PPM}	A	with a 10/1000us waveform	See Next Table
Power dissipation	P _D	W	On infinite heat sink at T _L =75°C	1.0
Peak forward surge current(2)	I _{FSM}	A	8.3 ms single half sine-wave unidirectional only	40
Operating junction and storage temperature range	T _J , T _{STG}	°C		-55 to +150

Electrical Characteristics (T_a=25°C Unless otherwise specified)

Item	Symbol	Unit	Conditions	Max
Maximum instantaneous forward Voltage (3)	V _F	V	at 25A for unidirectional only	3.5/5.0
Thermal resistance	R _{θJL}	°C/W	junction to lead	30
	R _{θJA}	°C/W	junction to ambient, L _{Lead} = 10 mm	120

Notes:

- (1) Non-repetitive current pulse, per Fig. 3 and derated above T_A = 25°C per Fig.2.
- (2) Mounted on 0.2 x 0.2" (5.0 x 5.0 mm) copper pads to each terminal
- (3) V_F<3.5V for devices of V_{BR}<200V and V_F<5.0V for devices of V_{BR}>201V

Electrical Characteristics ($T_A=25^\circ\text{C}$ unless otherwise noted)

Part Number(Uni)	Part Number(Bi)	$V_{BR@I_T}$ Breakdown Voltage $V_{BR@I_T}$			$I_R@V_{WM}$ Maximum Reverse Leakage $I_R^{(3)}$ (μA)	V_{RWM} Working Peak Reverse Voltage V_{RWM} (V)	IPP Maximum Reverse Surge Current IPP ⁽²⁾ (A)	Maximum Clamping Voltage V_C @ I_{PP} (V)
		Min(V)	Max (V)	$I_T^{(1)}$ (mA)				
SMAJ5.0	SMAJ5.0C	6.40	7.30	10	800	5.0	41.7	9.6
SMAJ5.0A	SMAJ5.0CA ⁽⁴⁾	6.40	7.07	10	800	5.0	43.5	9.2
SMAJ6.0	SMAJ6.0C	6.67	8.15	10	800	6.0	35.1	11.4
SMAJ6.0A	SMAJ6.0CA	6.67	7.37	10	800	6.0	38.8	10.3
SMAJ6.5	SMAJ6.5C	7.22	8.82	10	500	6.5	32.5	12.3
SMAJ6.5A	SMAJ6.5CA	7.22	7.98	10	500	6.5	35.7	11.2
SMAJ7.0	SMAJ7.0C	7.78	9.51	10	200	7.0	30.1	13.3
SMAJ7.0A	SMAJ7.0CA	7.78	8.60	10	200	7.0	33.3	12.0
SMAJ7.5	SMAJ7.5C	8.33	10.20	1.0	100	7.5	28.0	14.3
SMAJ7.5A	SMAJ7.5CA	8.33	9.21	1.0	100	7.5	31.0	12.9
SMAJ8.0	SMAJ8.0C	8.89	10.90	1.0	50	8.0	26.7	15.0
SMAJ8.0A	SMAJ8.0CA	8.89	9.83	1.0	50	8.0	29.4	13.6
SMAJ8.5	SMAJ8.5C	9.44	11.50	1.0	10	8.5	25.1	15.9
SMAJ8.5A	SMAJ8.5CA	9.44	10.4	1.0	10	8.5	27.8	14.4
SMAJ9.0	SMAJ9.0C	10.0	12.2	1.0	5.0	9.0	23.6	16.9
SMAJ9.0A	SMAJ9.0CA	10.0	11.1	1.0	5.0	9.0	26.0	15.4
SMAJ10	SMAJ10C	11.1	13.6	1.0	5.0	10.0	21.3	18.8
SMAJ10A	SMAJ10CA	11.1	12.3	1.0	5.0	10.0	23.5	17.0
SMAJ11	SMAJ11C	12.2	14.9	1.0	5.0	11.0	19.9	20.1
SMAJ11A	SMAJ11CA	12.2	13.5	1.0	5.0	11.0	22.0	18.2
SMAJ12	SMAJ12C	13.3	16.3	1.0	5.0	12.0	18.2	22.0
SMAJ12A	SMAJ12CA	13.3	14.7	1.0	5.0	12.0	20.1	19.9
SMAJ13	SMAJ13C	14.4	17.6	1.0	5.0	13.0	16.8	23.8
SMAJ13A	SMAJ13CA	14.4	15.9	1.0	5.0	13.0	18.6	21.5
SMAJ14	SMAJ14C	15.6	19.1	1.0	5.0	14.0	15.5	25.8
SMAJ14A	SMAJ14CA	15.6	17.2	1.0	5.0	14.0	17.2	23.2
SMAJ15	SMAJ15C	16.7	20.4	1.0	5.0	15.0	14.8	26.9
SMAJ15A	SMAJ15CA	16.7	18.5	1.0	5.0	15.0	16.4	24.4
SMAJ16	SMAJ16C	17.8	21.8	1.0	5.0	16.0	13.9	28.8
SMAJ16A	SMAJ16CA	17.8	19.7	1.0	5.0	16.0	15.4	26.0
SMAJ17	SMAJ17C	18.9	23.1	1.0	5.0	17.0	13.1	30.5
SMAJ17A	SMAJ17CA	18.9	20.9	1.0	5.0	17.0	14.5	27.6
SMAJ18	SMAJ18C	20.0	24.4	1.0	5.0	18.0	12.4	32.2
SMAJ18A	SMAJ18CA	20.0	22.1	1.0	5.0	18.0	13.7	29.2
SMAJ19	SMAJ19C	21.1	25.7	1.0	5.0	19.0	11.7	30.8
SMAJ19A	SMAJ19CA	21.1	23.3	1.0	5.0	19.0	13.0	30.8
SMAJ20	SMAJ20C	22.2	27.1	1.0	5.0	20.0	11.1	35.8
SMAJ20A	SMAJ20CA	22.2	24.5	1.0	5.0	20.0	12.3	32.4
SMAJ22	SMAJ22C	24.4	29.8	1.0	5.0	22.0	10.1	39.4
SMAJ22A	SMAJ22CA	24.4	26.9	1.0	5.0	22.0	11.3	35.5

Electrical Characteristics ($T_A=25^\circ\text{C}$ unless otherwise noted)

Part Number(Uni)	Part Number(Bi)	$V_{BR}@I_T$ Breakdown Voltage $V_{BR}@I_T$			$I_R@V_{WM}$ Maximum Reverse Leakage $I_R^{(3)}$ (μA)	V_{RWM} Working Peak Reverse Voltage V_{RWM} (V)	IPP Maximum Reverse Surge Current IPP ⁽²⁾ (A)	Maximum Clamping Voltage V_C @ I_{PP} (V)
		Min(V)	Max (V)	IT ⁽¹⁾ (mA)				
SMAJ24	SMAJ24C	26.7	32.6	1.0	5.0	24.0	9.3	43.0
SMAJ24A	SMAJ24CA	26.7	29.5	1.0	5.0	24.0	10.3	38.9
SMAJ26	SMAJ26C	28.9	35.3	1.0	5.0	26.0	8.6	46.6
SMAJ26A	SMAJ26CA	28.9	31.9	1.0	5.0	26.0	9.5	42.1
SMAJ28	SMAJ28C	31.1	38.0	1.0	5.0	28.0	8.0	50.0
SMAJ28A	SMAJ28CA	31.1	34.4	1.0	5.0	28.0	8.8	45.4
SMAJ30	SMAJ30C	33.3	40.7	1.0	5.0	30.0	7.5	53.5
SMAJ30A	SMAJ30CA	33.3	36.8	1.0	5.0	30.0	8.3	48.4
SMAJ33	SMAJ33C	36.7	44.9	1.0	5.0	33.0	6.8	59.0
SMAJ33A	SMAJ33CA	36.7	40.6	1.0	5.0	33.0	7.5	53.3
SMAJ36	SMAJ36C	40.0	48.9	1.0	5.0	36.0	6.2	64.3
SMAJ36A	SMAJ36CA	40.0	44.2	1.0	5.0	36.0	6.9	58.1
SMAJ40	SMAJ40C	44.4	54.3	1.0	5.0	40.0	5.6	71.4
SMAJ40A	SMAJ40CA	44.4	49.1	1.0	5.0	40.0	6.2	64.5
SMAJ43	SMAJ43C	47.8	58.4	1.0	5.0	43.0	5.2	76.7
SMAJ43A	SMAJ43CA	47.8	52.8	1.0	5.0	43.0	5.8	69.4
SMAJ45	SMAJ45C	50.0	61.1	1.0	5.0	45.0	5.0	80.3
SMAJ45A	SMAJ45CA	50.0	55.3	1.0	5.0	45.0	5.5	72.7
SMAJ48	SMAJ48C	53.3	65.1	1.0	5.0	48.0	4.6	85.5
SMAJ48A	SMAJ48CA	53.3	58.9	1.0	5.0	48.0	5.2	77.4
SMAJ51	SMAJ51C	56.7	69.3	1.0	5.0	51.0	4.4	91.1
SMAJ51A	SMAJ51CA	56.7	62.7	1.0	5.0	51.0	4.9	82.4
SMAJ54	SMAJ54C	60.0	73.3	1.0	5.0	54.0	4.1	96.3
SMAJ54A	SMAJ54CA	60.0	66.3	1.0	5.0	54.0	4.6	87.1
SMAJ58	SMAJ58C	64.4	78.7	1.0	5.0	58.0	3.9	103.0
SMAJ58A	SMAJ58CA	64.4	71.2	1.0	5.0	58.0	4.3	93.6
SMAJ60	SMAJ60C	66.7	81.5	1.0	5.0	60.0	3.7	107.0
SMAJ60A	SMAJ60CA	66.7	73.7	1.0	5.0	60.0	4.1	96.8
SMAJ64	SMAJ64C	71.1	86.9	1.0	5.0	64.0	3.5	114.0
SMAJ64A	SMAJ64CA	71.1	78.6	1.0	5.0	64.0	3.9	103.0
SMAJ70	SMAJ70C	77.8	95.1	1.0	5.0	70.0	3.2	125.0
SMAJ70A	SMAJ70CA	77.8	86.0	1.0	5.0	70.0	3.5	113.0
SMAJ75	SMAJ75C	83.3	102.0	1.0	5.0	75.0	3.0	134.0
SMAJ75A	SMAJ75CA	83.3	92.1	1.0	5.0	75.0	3.3	121.0
SMAJ78	SMAJ78C	86.7	106.0	1.0	5.0	78.0	2.9	139.0
SMAJ78A	SMAJ78CA	86.7	95.8	1.0	5.0	78.0	3.2	126.0
SMAJ80	SMAJ80C	88.9	108.8	1.0	5.0	80.0	2.8	143.2
SMAJ80A	SMAJ80CA	88.8	97.6	1.0	5.0	80.0	3.1	129.0
SMAJ85	SMAJ85C	94.4	115	1.0	5.0	85.0	2.6	151.0
SMAJ85A	SMAJ85CA	94.4	104	1.0	5.0	85.0	2.9	137.0

Electrical Characteristics ($T_A=25^\circ\text{C}$ unless otherwise noted)

Part Number (Uni)	Part Number (Bi)	$V_{BR}@I_T$ Breakdown Voltage $V_{BR}@I_T$			$I_R@V_{WM}$ Maximum Reverse Leakage $I_R^{(3)}$ (μA)	V_{RWM} Working Peak Reverse Voltage V_{RWM} (V)	IPP Maximum Reverse Surge Current IPP ⁽²⁾ (A)	Maximum Clamping Voltage V_c @ I_{PP} (V)
		Min(V)	Max (V)	$I_T^{(1)}$ (mA)				
SMAJ90	SMAJ90C	100	122	1.0	5.0	90.0	2.5	160.0
SMAJ90A	SMAJ90CA	100	111	1.0	5.0	90.0	2.7	146.0
SMAJ100	SMAJ100C	111	136	1.0	5.0	100.0	2.2	179.0
SMAJ100A	SMAJ100CA	111	123	1.0	5.0	100.0	2.4	162.0
SMAJ110	SMAJ110C	122	149	1.0	5.0	110.0	2.0	196.0
SMAJ110A	SMAJ110CA	122	135	1.0	5.0	110.0	2.2	177.0
SMAJ120	SMAJ120C	133	163	1.0	5.0	120.0	1.8	214.0
SMAJ120A	SMAJ120CA	133	147	1.0	5.0	120.0	2.1	193.0
SMAJ130	SMAJ130C	144	176	1.0	5.0	130.0	1.7	231.0
SMAJ130A	SMAJ130CA	144	159	1.0	5.0	130.0	1.9	209.0
SMAJ140	SMAJ140C	155	190	1.0	5.0	140.0	1.6	250.6
SMAJ140A	SMAJ140CA	155	171	1.0	5.0	140.0	1.7	226.8
SMAJ150	SMAJ150C	167	204	1.0	5.0	150.0	1.5	268.0
SMAJ150A	SMAJ150CA	167	185	1.0	5.0	150.0	1.6	243.0
SMAJ160	SMAJ160C	178	218	1.0	5.0	160.0	1.4	287.0
SMAJ160A	SMAJ160CA	178	197	1.0	5.0	160.0	1.5	259.0
SMAJ170	SMAJ170C	189	231	1.0	5.0	170.0	1.3	304.0
SMAJ170A	SMAJ170CA	189	209	1.0	5.0	170.0	1.4	275.0
SMAJ180	SMAJ180C	200	244	1.0	5.0	180.0	1.2	322.2
SMAJ180A	SMAJ180CA	200	220	1.0	5.0	180.0	1.3	291.6
SMAJ190	SMAJ190C	211	258	1.0	5.0	190.0	1.2	340.1
SMAJ190A	SMAJ190CA	211	232	1.0	5.0	190.0	1.3	307.8
SMAJ200A	SMAJ200CA	224	247	1.0	1.0	200.0	1.2	324.0
SMAJ220A	SMAJ220CA	246	272	1.0	1.0	220.0	1.1	356.0
SMAJ250A	SMAJ250CA	279	309	1.0	1.0	250.0	1.0	405.0
SMAJ300A	SMAJ300CA	335	371	1.0	1.0	300.0	0.8	486.0
SMAJ350A	SMAJ350CA	391	432	1.0	1.0	350.0	0.7	567.0
SMAJ400A	SMAJ400CA	447	494	1.0	1.0	400.0	0.6	648.0
SMAJ440A	SMAJ440CA	492	543	1.0	1.0	440.0	0.5	713.0

Notes:

- (1) $t_p \leq 50\text{ms}$ Pulse test: $t_p \leq 50\text{ms}$
- (2) Surge current waveform per Fig. 3 and derated per Fig.2.
- (3) For bi-directional types having VWM of 10 V and less, the I_R limit is doubled
- (4) For the bi-directional SMAJ5.0CA, the maximum V_{BR} is 7.25 V

Typical Characteristics

FIG1: Peak Pulse Power Rating Curve

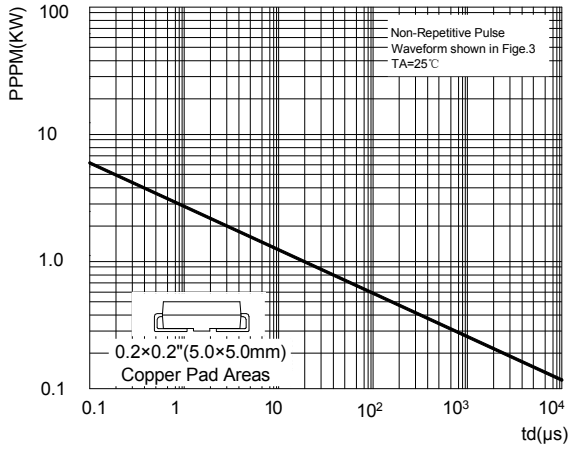

FIG2: Pulse Power or Current vs. Initial Junction Temperature

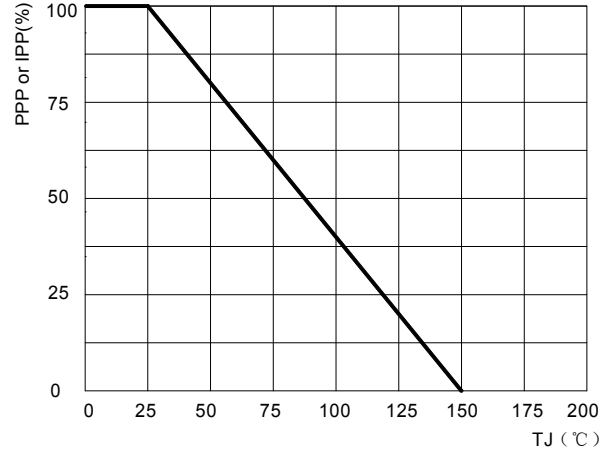

FIG3: Pulse Waveform

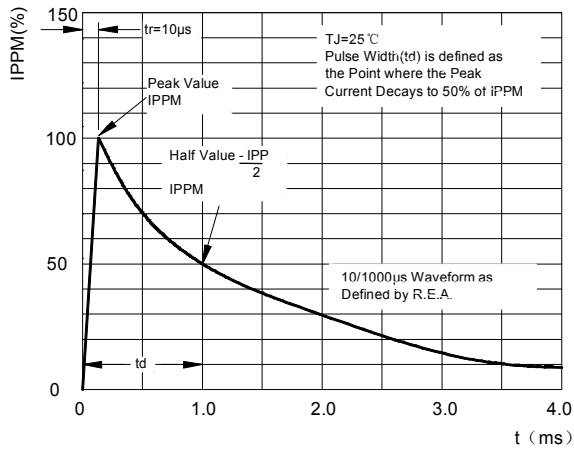

FIG4: Typical Transient Thermal Impedance

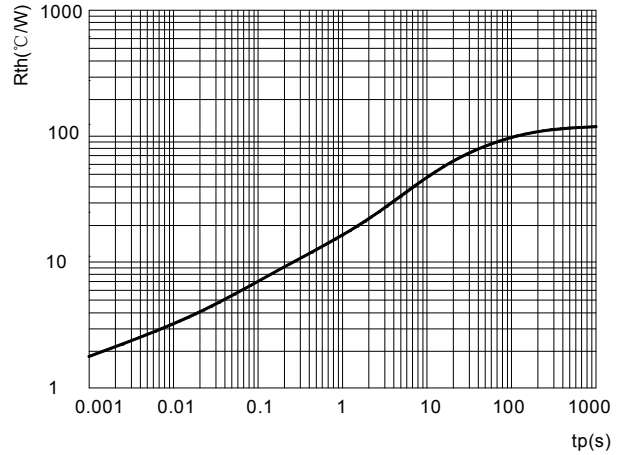

FIG5: Maximum Non-Repetitive Surge Current

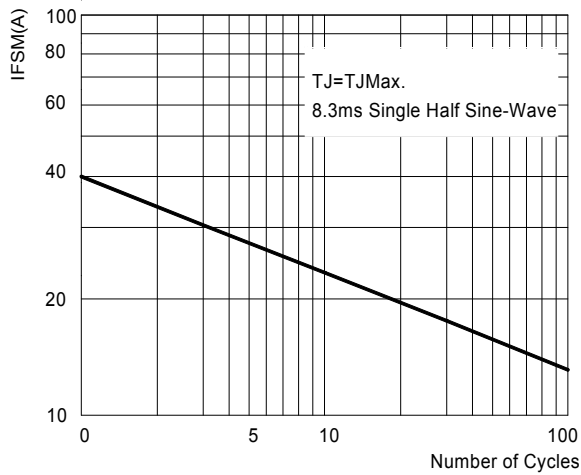
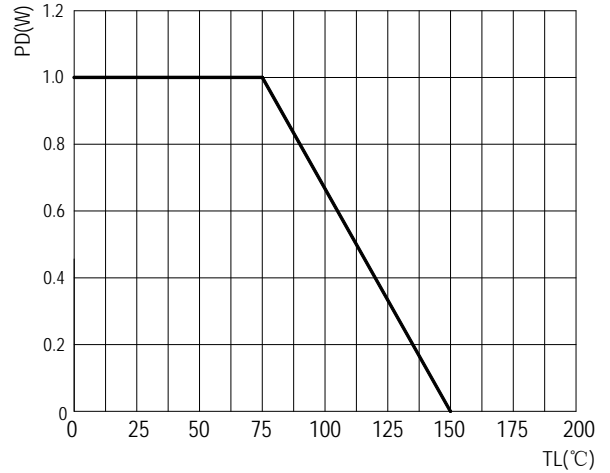
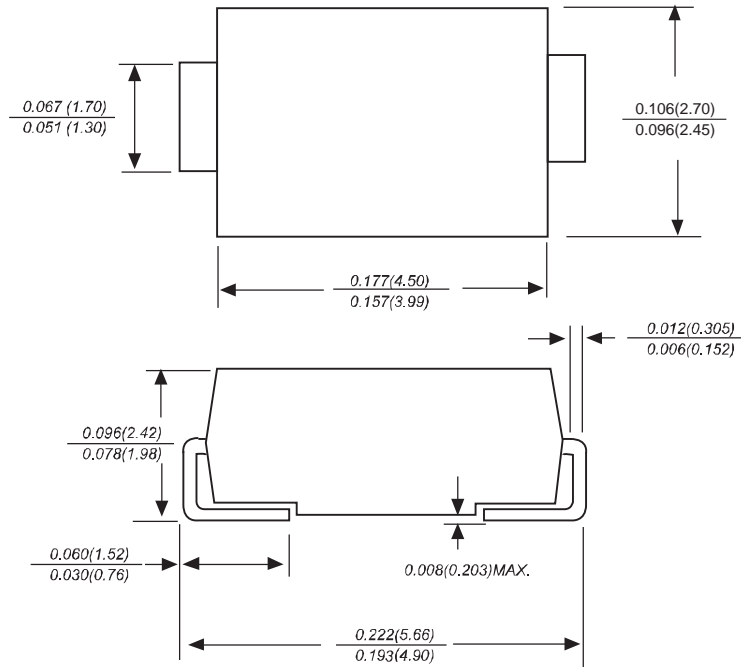

FIG6: Steady State Power Dissipation



SMAG Package Outline Dimensions



Dimensions in inches and (millimeters)

SMAG Suggested Pad Layout

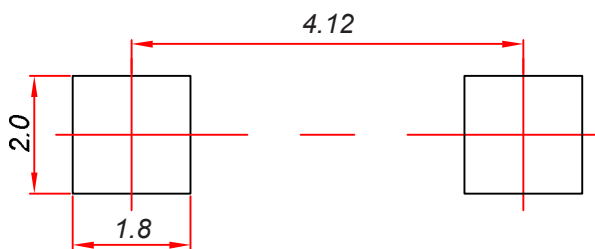

Note:

1. Controlling dimension: in millimeters.
2. General tolerance: ± 0.05 mm.
3. The pad layout is for reference purposes only.

NOTICE

JSCJ reserves the right to make modifications, enhancements, improvements, corrections or other changes without further notice to any product herein. JSCJ does not assume any liability arising out of the application or use of any product described herein.

Reel Taping Specifications For Surface Mount Devices- SMAG

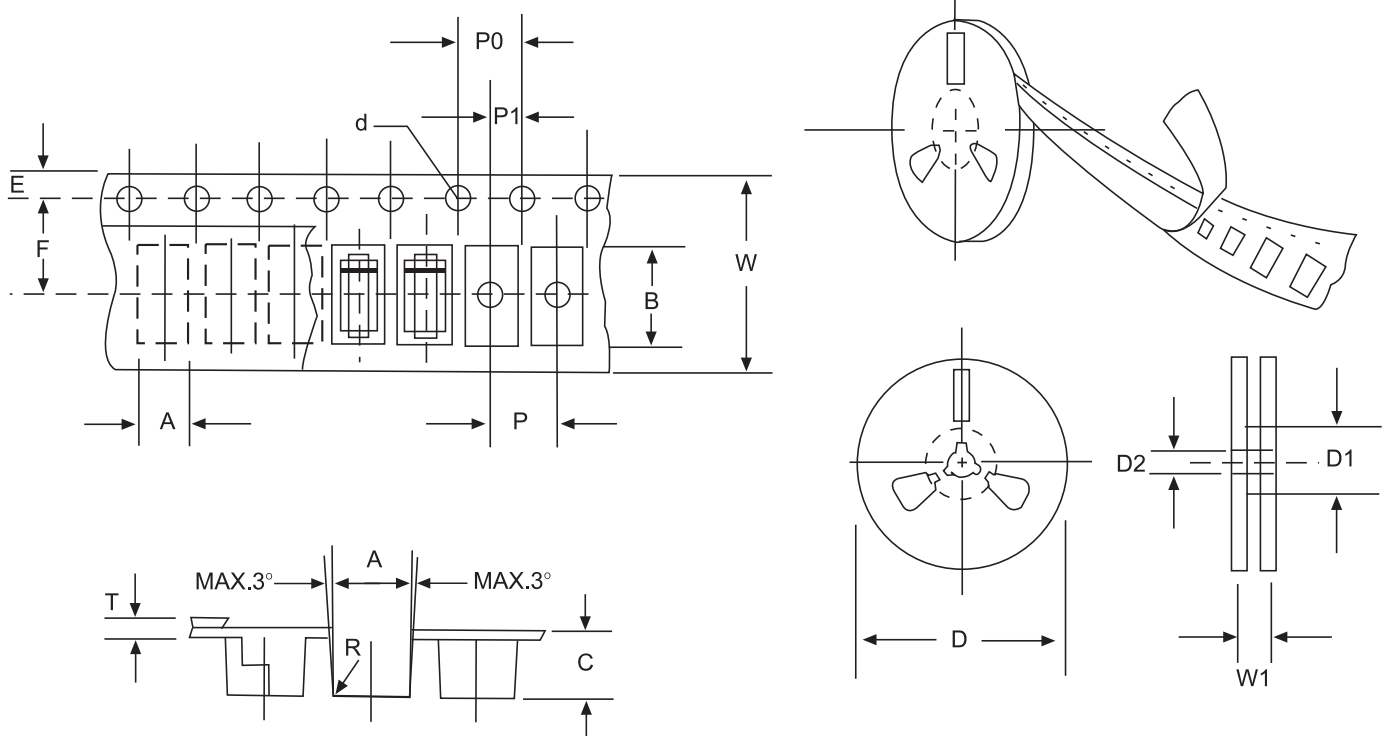

FIG: CONFIGURATION OF SURFACE MOUNTED DEVICES TAPING

ITEM	SYMBOL	SMAG mm(inch)
Carrier width	A	2.79±0.1(0.110±0.004)
Carrier length	B	5.33±0.1(0.210±0.004)
Carrier depth	C	2.36±0.1(0.093±0.004)
Sprocket hole	d	1.55±0.05(0.061±0.002)
Reel outside diameter	D	279±2.0 (11± 0.079)
Reel inner diameter	D1	75 ±1.0 (2.95 ±0.039)
Feed hole diameter	D2	13±0.5(0.512±0.020)
Sprocket hole position	E	1.75±0.1(0.069±0.004)
Punch hole position	F	5.5±0.05(0.217±0.002)
Punch hole pitch	P	4.0±0.1(0.157±0.004)
Sprocket hole pitch	P0	4.0±0.1(0.157±0.004)
Embossment center	P1	2.0±0.1(0.079±0.004)
Totall tape thickness	T	0.28±0.02(0.011 ±0.0008)
Tape width	W	12.0±0.2(0.472±0.008)
Reel width	W1	16.8±2.0(0.661±0.079)

NOTE: Devices are packed in accordance with EIA standard RS-481-A and specification given above.